



POWER ELECTRONICS

— SINCE 1999 —



POWER ELECTRONICS

**CONTROLLATE LE VIBRAZIONI E AVRETE
IL POTERE DI CONTROLLARE LA SOSTANZA
E L'ENERGIA DELLA MATERIA**

***CONTROL THE VIBRATIONS AND THE POWER
TO CONTROL SUBSTANCE AND MATERIAL
ENERGY WILL EVENTUALLY BE GIVEN***

JASMUHEEN

DIODI AD ALTA TENSIONE

HIGH VOLTAGE RECTIFIERS



01

Dispositivi sigillati ermeticamente in tubi ceramici. Adatti per connessioni a saldare o a serraggio. Possono essere montati in aria o in olio. Dispositivi con caratteristiche a valanga. Da 2,5 KV a 180 KV.

Hermetically sealed in ceramic tubes devices. Suitable for solder or screw connections or clip-on contacts. They can be mounted in air or oil. Avalanche characteristics. From 2,5 KV to 180 KV.

CARATTERISTICHE TECNICHE COME PUNTI DI FORZA

- > Tensioni da 2,5 KV a 180 KV
- > Correnti da 0,25 A a 30 A
- > Sigillati ermeticamente in tubi ceramici
- > Adatti per connessioni a saldare o a serraggio
- > Possono essere montati in aria o in olio
- > Caratteristica a valanga
- > Ingombro ridotto

CAMPI DI APPLICAZIONE

- > Elettromedicale
- > Test qualità isolamento cavi elettrici
- > Apparecchiature Laser
- > Apparecchiature a Raggi X
- > Film sottile
- > Alimentatori HV
- > Attrezzatura misura AT

OCRAM si distingue per questi plus di prima qualità: la capacità di **personalizzare ogni strumento modellandolo sulle esigenze del cliente anche per pezzi singoli**; l'assoluta **sicurezza in fase operativa** che garantisce l'incolumità da qualsiasi danno; **la puntualità nelle consegne** (zero delay policy) e una accurata assistenza al cliente pre e post vendita.

PUNTI DI FORZA ED APPLICAZIONI



AC/DC

ALIMENTATORI

**TECHNICAL SPECS
AS STRENGTHS**

- > 2,5 KV ÷ 180 KV
- > 0,25 A ÷ 30 A
- > Hermetically sealed in ceramic tubes
- > Suitable for solder or screw connections
- > Can be mounted in air or oil
- > Avalanche characteristics
- > Reduced overall dimensions

**APPLICATION
FIELDS**

- > Diagnostic medical equipments
- > High Voltage power supplies
- > Lasers
- > X-Ray equipment
- > Electronic beam welding
- > Electrostatic precipitators
- > Cable test Equipments

OCRAM provides its customers with the highest quality standards.

We can satisfy our customers' needs by **dimensionally customizing our devices**, guaranteeing the most accurate operational safety standards, in pursuing a **zero delay policy** and ensuring a total customer care.

STRENGTHS AND APPLICATIONS



AC/DC

POWER
SUPPLIES

DIODI AD ALTA TENSIONE

HIGH VOLTAGE RECTIFIERS

> TECHNICAL DATA

DS_OCR_O3
REV.00 – 22/04/2010

V _{RRM}	V _(BR)	V _{VRMS}	Types	I _{FAV} T _{amb} = 45°C A	I _{FAV} T _{oil} = 45°C A	I _{FN} T _{amb} = 45°C A	V _F I _F = 1A V	N	R _{thjα} °C/W
------------------	-------------------	-------------------	-------	---	---	--	--	---	---------------------------

> High Voltage Rectifiers < 50 KV HSK E

6 000	7 500	2 500	HSK E 2500/1100-0,3	0,45	0,45	0,3	5	5	60
8 000	10 000	3 500	HSK E 3500/1550-0,3	0,4	0,4	0,3	7	7	50
12 000	15 000	5 000	HSK E 5000/2200-0,25	0,35	0,35	0,25	10	10	45
8 000	10 000	3 500	HSK E 3500/1550-0,5	0,65	0,78	0,5	8	7	25
12 000	15 000	5 000	HSK E 5000/2200-0,5	0,6	0,72	0,5	11	10	15
16 000	20 000	7 500	HSK E 7500/3300-0,4	0,55	0,66	0,4	16	15	15
24 000	30 000	10 000	HSK E 10000/4500-0,4	0,5	0,6	0,4	20	19	13
32 000	40 000	14 000	HSK E 14000/6300-0,4	0,5	0,6	0,4	27	26	10
40 000	50 000	17 000	HSK E 17000/7600-0,3	0,45	0,54	0,3	32	32	9
8 000	10 000	3 500	HSK E 3500/1550-1,2	1,5	1,8	1,2	8	7	10
12 000	15 000	5 000	HSK E 5000/2200-1,2	1,45	1,75	1,2	11	10	7
16 000	20 000	7 500	HSK E 7500/3300-1,2	1,35	1,6	1,2	16	14	5,5
24 000	30 000	10 000	HSK E 10000/4500-1,2	1,3	1,55	1,2	20	19	5
8 000	10 000	3 500	HSK E 3500/1550-2	2,9	3,5	2,0	9	7	-

Symbol	Conditions	HSK...-0,3 -0,25 -0,4 -0,5	HSK...-1,2	HSK...-2
I _{F(OV)}	tp = 1 s tp = 100 ms	1 A 2,5 A	2 A 5 A	4 A 10 A
I _{FSM}	T _{vj} = 25 °C T _{vj} = 150 °C	60 A 50 A	140 A 120 A	270 A 240 A
i ² t	T _{vj} = 25 °C T _{vj} = 150 °C	18 A ² s 12,5 A ² s	100 A ² s 72 A ² s	365 A ² s 290 A ² s
I _R	T _{vj} = 25 °C: V _R = V _{RRM} T _{vj} = 25 °C: tp = 10 μs	5 μA 0,5 A	5 μA 1 A	5 μA 2 A
I _{RSM}	T _{vj} = 150 °C: tp = 10 μs	0,5 A	0,8 A	1,6 A
T _{vj} T _{stg}		- 40...+150 °C - 40...+150 °C		
Case		F 1/F 2	F 2	F 2

< 50 KV HSK E

DS_OCR_O3
REV.00 - 22/04/2010

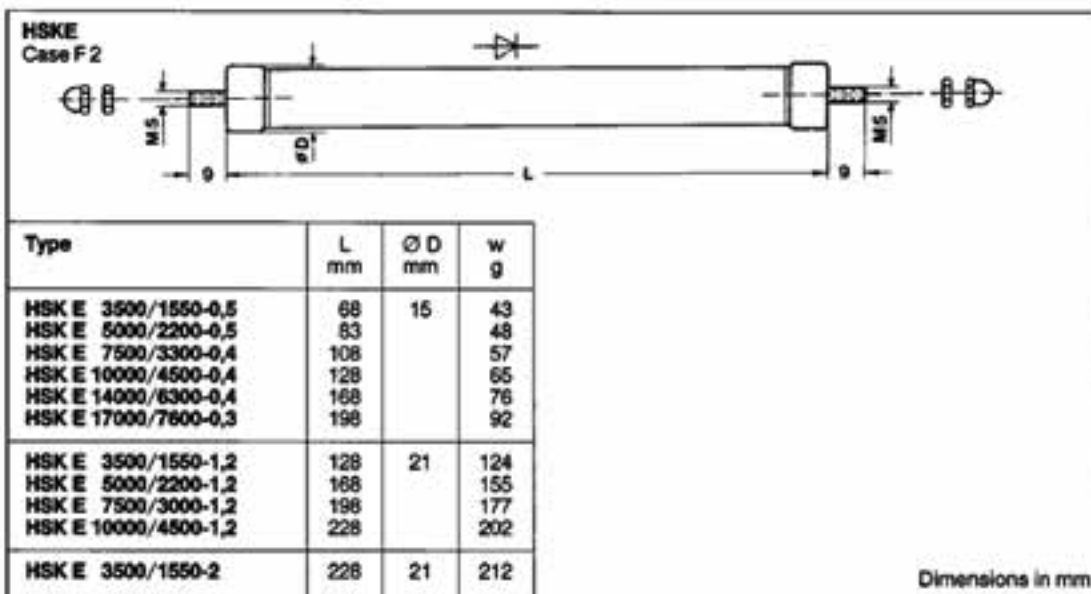
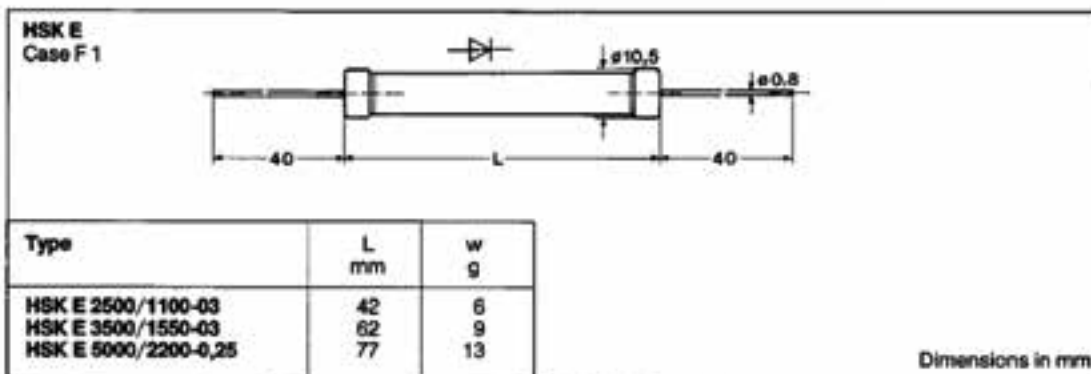

< 50 KV HSK E

DS_OCR_O3
REV.00 - 22/04/2010

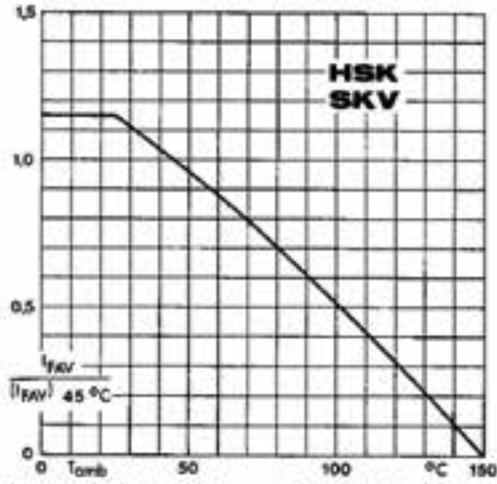

Fig. 1 Rated forward current vs. ambient temperature

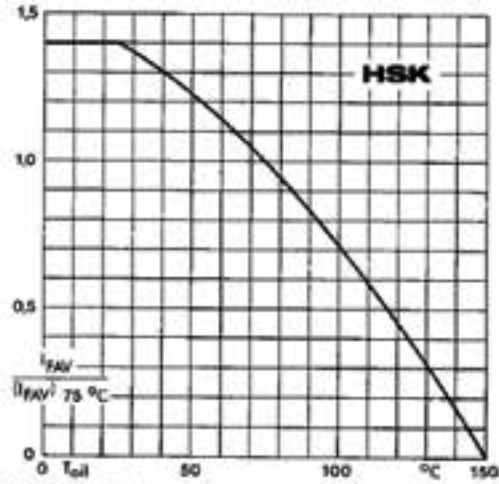

Fig. 2 Rated forward current vs. oil temperature

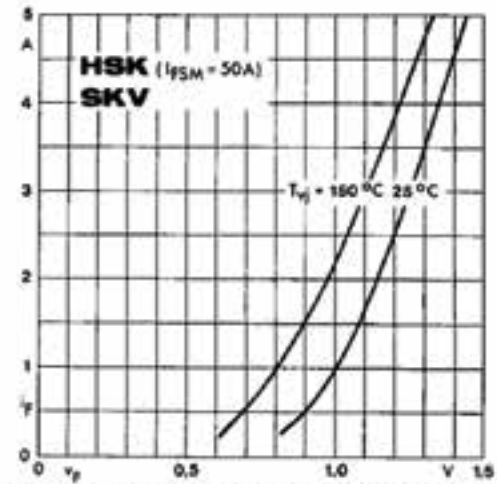

Fig. 5 a Forward characteristic of a single chip

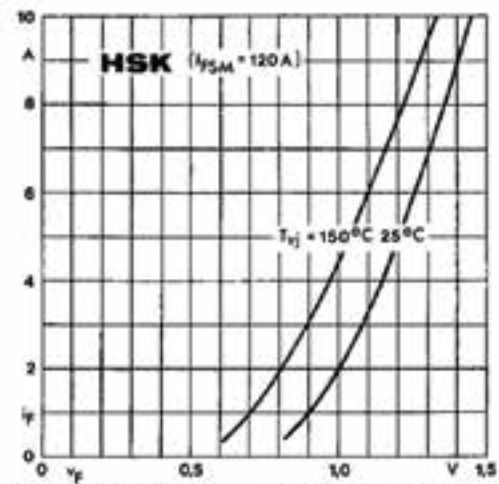

Fig. 5 b Forward characteristic of a single chip

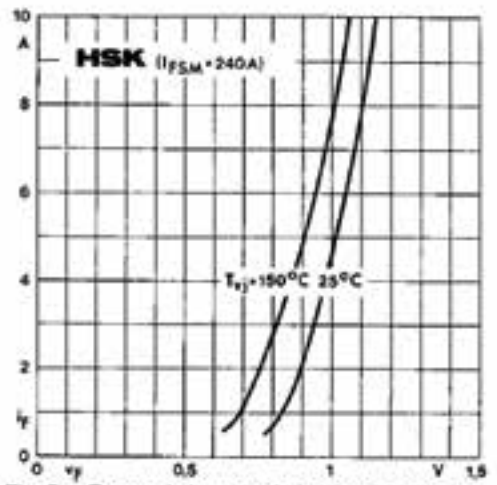

Fig. 5 c Forward characteristic of a single chip

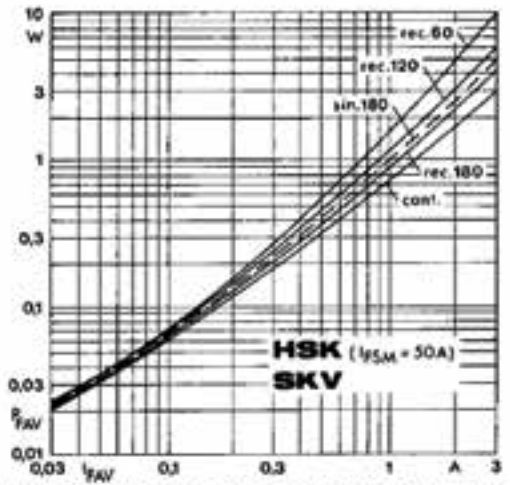

Fig. 6 a Power dissipation per chip vs. forward current

< 50 kV HSK E

DS_OCR_O3
REV.00 - 22/04/2010

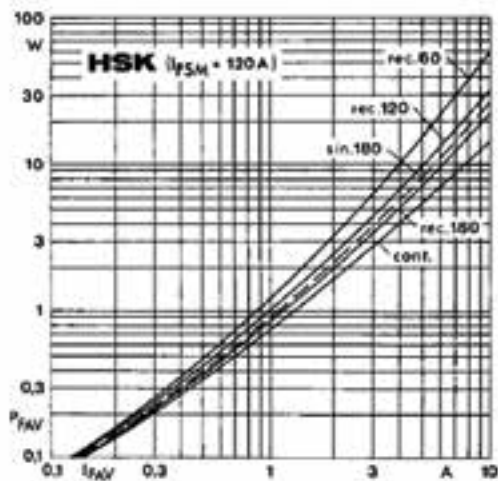

Fig. 6 b Power dissipation per chip vs. forward current

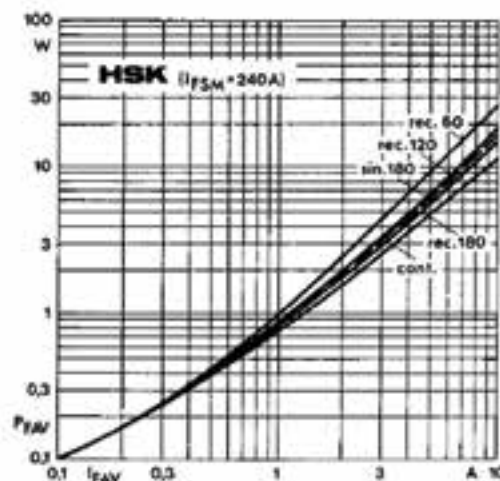

Fig. 6 c Power dissipation per chip vs. forward current

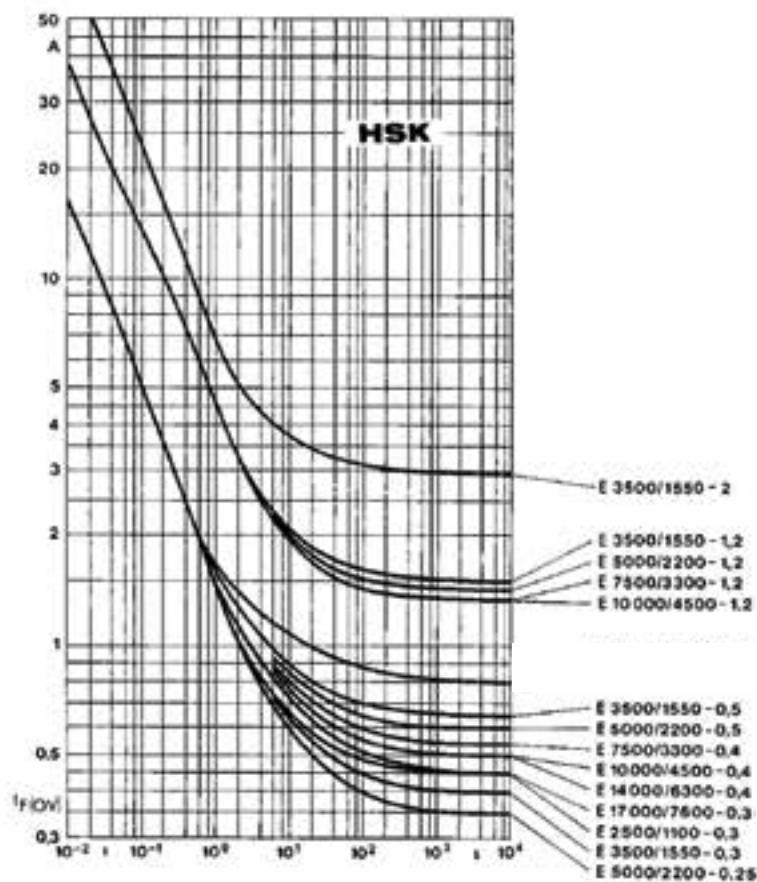
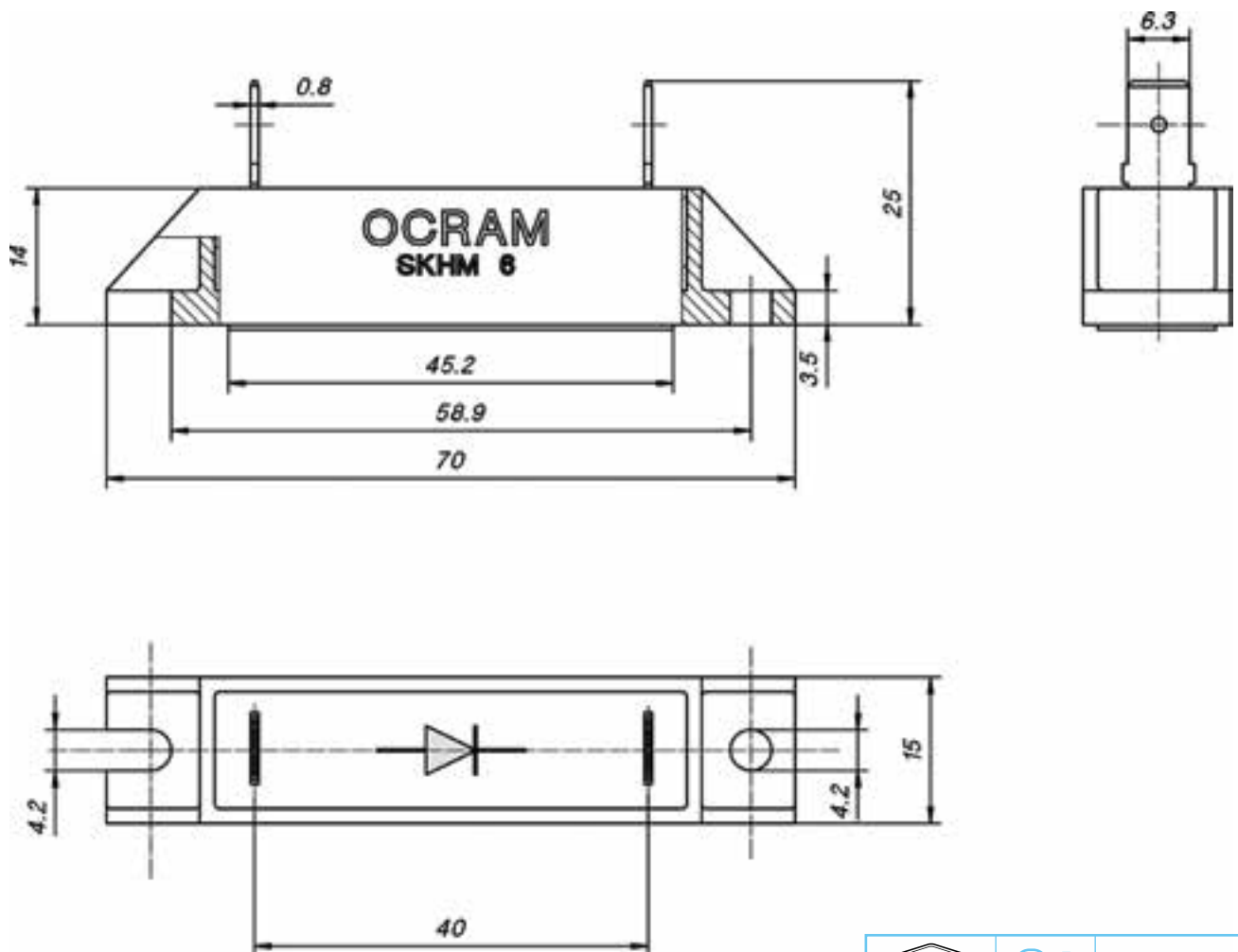
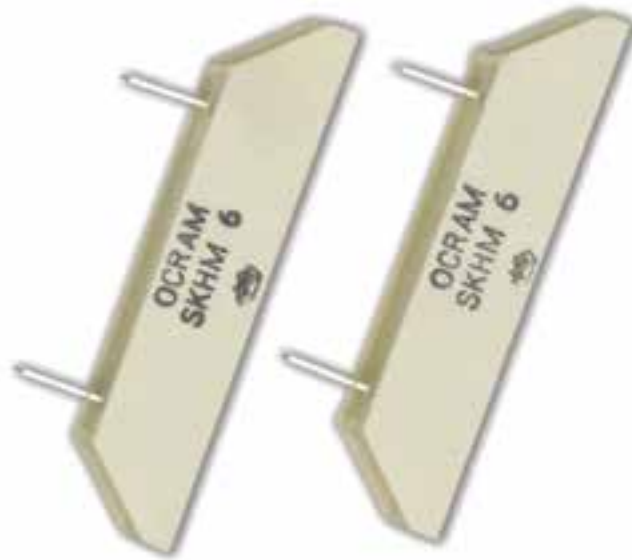

Fig. 9 Rated overload current vs. time

Parameters	Conditions	Values	Units
SKHM6			
V _{rsm}		6000	V
V _{rrm}		6000	V
I _{Fav}	T _{case} = 49°C, sin. 180°C	6,4	A
I _{Fav}	T _{case} = 45°C, rec. 180°C	7	A
I _{Frms}		10	A
I _{Fsm}	T _{vj} = 25°C	60	A
I _{Fsm}	T _{vj} = 130°C	50	A
I ² _t	T _{vj} = 25°C	18	A ² s
I ² _t	T _{vj} = 130°C	12,5	A ² s
I _r	T _{vj} = 25°C	max. 2	μA
V _f	I _f = 10A	max. 8	V
V _(to)	T _{vj} = 130°C	5	V
r _f	T _{vj} = 130°C	300	mΩ
R _{thjα}		25	°C/W
R _{thjc}		1,3	°C/W
R _{thch}		0,5	°C/W
T _{vj}		da -25 a +130	°C
T _{stg}		da -25 a +150	°C
Weight		ca. 23	g
Visol		9000	V~

< SKHM6

DS_OCR_O9
REV.00 - 10/02/2015



DIODI AD ALTA TENSIONE

HIGH VOLTAGE RECTIFIERS

DS_OCR_O4
REV.00 - 22/4/2010

VRRM	V(BR)	VRWM	Types	V _F I _F = 30 A	N	R _{thjcoil}
V	V	V		V		°C/W

> **High Voltage Rectifiers 80 ÷ 180 KV SKXA**

80 000	100 000	75 000	SKXA 75 000	160	54	2,6
80 000	100 000	75 000	SKXA 75 M	210	61	2,3
105 000	130 000	100 000	SKXA 100 M	225	74	2,2
160 000	200 000	150 000	SKXA 150 M	340	108	1,4
180 000	220 000	170 000	SKXA 180 M	340	108	1,4

Symbol	Conditions	SKXA
I _{FAV}	T _{oil} = 75°C	0,35 A
I _{FN}	T _{amb} = 45°C	0,28 A
I _{F(OV)}	tp = 1s tp = 100 ms	2,6 A 7,5 A
I _{FSM}	T _{vj} = 25 °C; 10 ms T _{vj} = 125 °C; 10 ms	100 A 90 A
i ² t	T _{vj} = 25 °C; 8,3 ... 10 ms T _{vj} = 125 °C; 8,3 ... 10 ms	50 A ² s 40 A ² s
I _R	T _{vj} = 25 °C; V _R = VRRM	1,5 μA
T _{vj} T _{stg}		- 40...+125 °C - 40...+125 °C
Case		F3

INSTALLATION NOTES: THE DIODES HAVE TO BE FIXED IN AN ELASTIC WAY, FOR EXAMPLE WITH SPRINGS OR CLIPS.

NOTE DI INSTALLAZIONE: I DIODI DEVONO ESSERE MONTATI IN MANIERA ELASTICA, PER ESEMPIO TRAMITE MOLLE O CLIPS.

80 ÷ 180 KV SKXA

DS_OCR_O4
REV.00 - 22/04/2010

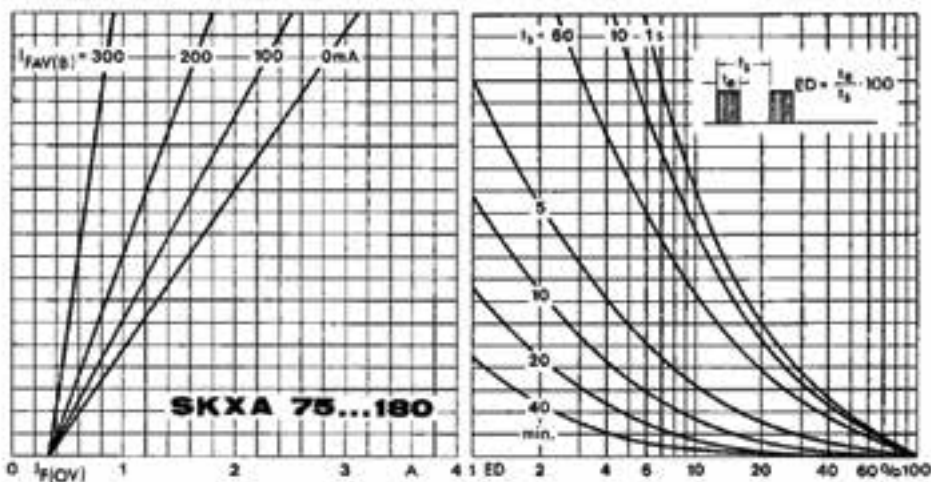

Fig. 7 Rated overload current vs. duty cycle

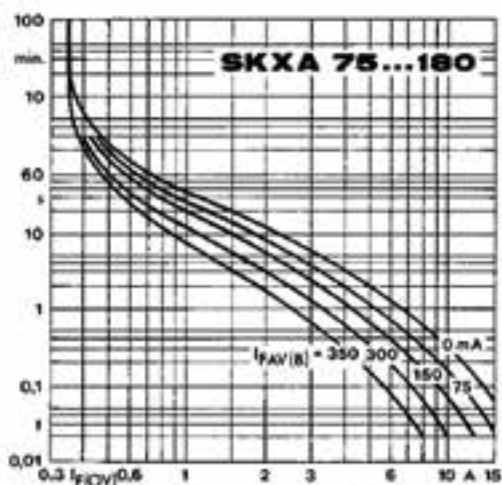
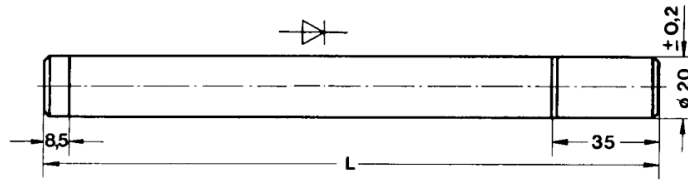

Fig. 8 Rated overload current vs. time

SKXA
Case F 3



Type	L_{-2}^{+1} mm	w g
SKXA 75000	124	105
SKXA 75 M	142	118
SKXA 100 M	170	143
SKXA 150 M	230	192
SKXA 180 M	230	192

Dimensions in mm

CONTATTI

CONTACTS

Ocram S.r.l. - Power Electronics

Via Rovigo, 1 - 36031 Dueville (VI)

Italy

Tel. +39 0444.946448

Fax +39 0444.298900

info@ocramitaly.it

www.ocramitaly.it

Il catalogo è disponibile on line su www.ocramitaly.it

This catalogue is available on line on www.ocramitaly.it